

USER MANUAL AND INSTALLATION

KOXA



casals
fans of innovation

INDEX

SECURITY RULES AND MARKING CE	p.3
GENERAL RULES	p.3
MAINTENANCE	p.3
EQUIPMENT WARRANTY	p.3
CONDITIONS OF INSTALLATION	p.5
RESIDUAL RISKS	p.5
SIGNALS PLACED ON THE MACHINE	p.5
- Prohibition signs	
- warning information signs	
- identification signs	
RECEPTION OF THE MERCHANDISE	p.6
DISPLACEMENT	p.6
STORAGE	p.6
PROLONGED STOP	p.6
START UP	p.6
ASSEMBLY AND DISASSEMBLY	p.6
ELIMINATION	p.6
LIFTING AND POSITIONING	p.7
CONDENSED TRAY	p.7
WIRING DIAGRAMS	p.8
ACCESSORIES- CUTTING SWITCH	p.11
ACCESSORIES- PRESSOSTAT	p.12
ACCESSORIES- CONSTANT FLOW (AC MOTORS)	p.12
ACCESSORIES- CO ₂ CONTROL (AC MOTORS)	p.14
WATER COIL	p.15
DIRECT EXPANSION COIL	p.15
ELECTRICAL COIL	p.15
HUMIDIFIER	p.17
RECUPERATOR	p.17
TROUBLESHOOTING	p.18
DECLARATION OF CONFORMITY	p.19

KOXA

SECURITY AND MARKING STANDARDS "CE"

Our R & D department is concerned with achieving efficient products in compliance with the current "safety standards". The rules and recommendations set out below mainly reflect what is in effect in safety material and therefore are mainly based on compliance with the general rules. Therefore, we strongly recommend all the people who manipulate the machine to follow the rules of accident prevention in their place and in their country. Casals ventilation is exempt from any liability for any damage caused to people or property arising from non-compliance with safety regulations, as well as any changes made to the product.

The CE marking and the relative declaration of conformity certify compliance with applicable Community standards. Products that are not marked on the CE plate must be completed by the buyer who must then certify the entire plant, thus providing the certificate of conformity.

The machines meet the requirements of:

- Machinery Directive 2006/42 / CE.
- Low voltage directive 2014/35 / CE.
- With the Electromagnetic Compatibility Directive 2014/30 / CE.
- Ecodesign Directive 2009/125 / CE.

GENERAL RULES

Safety guards should not be removed if it is not due to absolute need for work; in which case appropriate measures must be taken that must be taken immediately in the event of possible danger.

All maintenance work (ordinary and extraordinary) must be carried out with the machine stopped, electrical power, pneumatic etc ... disconnected. To avoid the danger of accidental insertion, stick on electrical panels, control units and control consoles warning signs with the words "Warning: command excluded for maintenance in progress". Before connecting the power cable to the terminal board verify that the line voltage is suitable for that shown on the machine's plate, pay attention to the labels placed on the product; if time goes by they should become illegible and they would have to be replaced.

The device must not be used by people (including children) whose physical, sensory or mental abilities are reduced, or with lack of experience or knowledge, unless they have been able to benefit, through the intermediation of a responsible person in their security, surveillance or instructions on the use of the device. Children should be checked to prevent them from playing with the device.

MAINTENANCE

The maintenance staff, in addition to having to observe the current legal provisions on accident prevention, must comply with the instructions shown below:

- Wear appropriate safety clothing.
- Use soundproof headphones when the noise exceeds the allowed limit.
- Verify the existence of an interlock that foresees the start-up of the machine by other people.

These heat recovery systems lack the maintenance periodically to perform correctly the function for which they were designed. The frequency with which maintenance is performed depends on the characteristics of the environment in which the device is inserted and the number of hours of operation, so what is indicated below should be seen as guidance.

Fan

Operations to be carried out:

- Check if there are no foreign bodies inside the module.
- Check that all screws are tightened to avoid unwanted vibrations.
- General interior cleaning.

Maintenance interval: half-yearly

Filters

Operations to be carried out:

- Check if there are no foreign bodies inside the module.
- Check that all screws are tightened to avoid unwanted vibrations.
- Check if there are no cuts in the filter mat.
- Check the clogging status of the filters (clean or replace if necessary).
- General interior cleaning.

Maintenance frequency: monthly

Heat recovery

Operations to be carried out:

- Check if there are no foreign bodies inside the module.
- Check that all screws are tightened to avoid unwanted vibrations.
- Check the condition and fixing and cleaning of the recovery element.
- General interior cleaning.

Maintenance interval: half-yearly

Water coil

Operations to be carried out:

- Check if there are no foreign bodies inside the module.
- Check that all screws are tightened to avoid unwanted vibrations.
- Check the connections to the battery.
- Check and clean (if necessary and with care not to cause damage) the fins of the batteries.
- If there are deformed fins, place them in the correct position with a suitable "comb".
- General interior cleaning

Maintenance frequency: annual

Electric coil

- Check if there are no foreign bodies inside the module.
- Check that all screws are tightened to avoid unwanted vibrations.
- Check the state of the connections, replacing and re-making connections if necessary.
- General interior cleaning.

Maintenance interval: half-yearly

EQUIPMENT WARRANTY

Casals Ventilation warrants this product against all manufacturing defects for a period of two (2) years from the date of purchase.

The service under warranty, will only be paid by presenting the purchase receipt, which shows that the machine is within the warranty period. If, during the guarantee period, the product resulting from recognizing the problems of manufacturing defects, Casals ventilation or its authorized technical services, shall, to the free repair on site or (according to the criteria of Casals ventilation) to replace the product or make available to the customer for the replacement of defective components according to the following conditions. Casals ventilation reserves the right, (at its own discretion) to replace the components of defective products or low-value products, both components or new products, such as components or recycled products.

Warranty exclusions

- Pieces of natural wear.
- Parts subject to deterioration or breaking, for example belts, filters, fuses, etc.
- Failures caused by misuse, neglect, negligence, atmospheric discharges, floods, humidities, falls, crashes, accidents and transportation.
- Failures caused due to the use of equipment for purposes other than those foreseen.

Failures caused as a result of manipulation, change or repair of equipment by unauthorized persons or technical services or due to the use of inappropriate parts or accessories.

Faults caused due to incorrect or illegal installation (voltage, water pressure or other), power anomalies, non-compliance with the instructions.

- Wear or aesthetic deterioration, resulting from the use, changes in tones, oxidation or corrosion of the device or its components.
- A possible repair does not result in the continuation of the warranty nor will it entitle any compensation.

The guarantee does not apply every time ...

- The type plate of the equipment is tampered with or tampered with.
- False data is provided.
- Do not accompany the equipment with the purchase document.
- The equipment is manipulated, changed or repaired by unauthorized persons or technical services.
- Verification / maintenance operations are not carried out or are carried out by unauthorized technicians.

CONDITIONS OF INSTALLATION

The installation inside or outside buildings with an ambient temperature between -15 ° and + 50 ° C

It should be avoided:

- Areas near heat sources, steam, gas or flammable liquids and / or explosives, especially dusty areas, proximity to water sources such as tanks, showers or swimming pools. Do not touch the appliance with wet or damp hands or feet. Do not leave the device exposed to atmospheric agents.

Must be:

- Use the device only for the use for which it has been expressly manufactured. The manufacturer is not liable for possible damages arising from improper or incorrect uses.
- Consider an area where the air drive and the noise of the unit do not cause discomfort to neighbors.
- Consider a position that respects the minimum spaces (as indicated in this manual).
- Consider a position that does not obstruct steps or entries.
- The degree of protection of the unit is IP20.

In case of installation abroad:





- Place the unit in a place protected from atmospheric agents.
- Use the corresponding rain protection cover (if necessary together with the corresponding protection hoods with net). In this case, the degree of protection becomes IP22.

RESIDUAL RISKS

The risk analysis of the products has been carried out according to the Machinery Directive (Annex I of Directive 2006/42 / EC). This manual contains the information for all the exposed personnel in order to prevent possible damages to people and / or things due to residual risks.

SIGNALS PLACED ON THE MACHINE

Various signaling pictograms may be present on the machine, which must not be removed. This signals are divided into:

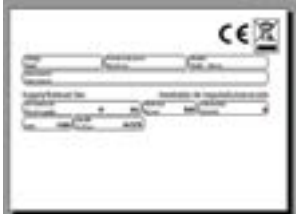
- PROHIBITION SIGNALS	
- Do not repair or adjust during motion.	
- DANGER AND INFORMATION SIGNALS	
- Attention to the presence of electric current.	
- Automatic start Danger.	
- Attention to the instruction manual.	
- Grounding the machine.	
- PRODUCT MARKING	
	

RECEPTION OF THE MERCHANDISE

Each product is checked carefully before shipment. At the time of reception, check that the product has not been damaged during transport; otherwise, communicate the incident to the carrier. The carrier is responsible for possible damages derived from transportation. The products are packed in pallets and fixed to it by strips and protective film, or in self-supporting cardboard boxes, properly fixed to the pallet.

DISPLACEMENT

Before moving the product, make sure that the medium used has adequate capacity. For lifting, use forklifts, lifting the pallet. The maximum hand lift is specified in the 89/391 / EEC standard and later. It is generally acceptable a weight of 20 kg below the back but above ground level.

STORAGE

Store the unit in a sheltered place, without excessive humidity and not subject to strong temperature fluctuations, in order to avoid the formation of condensation inside the unit. Storage is not recommended for a period longer than one year. If more than one year is stored, it is necessary to check the free rotation of the bearings before installation (turn the turbine by hand).

PROLONGED STOP

In case of prolonged shutdown, with the unit connected to the ventilation system, close the suction / discharge ducts and periodically check the absence of humidity inside the machine. In case of moisture formation, dry it immediately.

START UP

Before commissioning, it is advisable to carry out some checks (follow the safety instructions set out in the DISMOUNTING AND ASSEMBLY section):

- Make sure that there is no condensation inside the unit, and if necessary dry it before putting the unit into operation.
- Check the status of the filters.
- Make sure that the interior of the product has no foreign bodies and that all the components are fixed in their seats.
- Manually test that the turbine does not rub against the suction mouth of the machine.
- Check that the inspection gate is closed.

ATTENTION:

If the mouths of a fan are not properly holed, a suitable protection net must be provided. Check the electrical ground connection. The electrical connection must be made by qualified personnel.

DISASSEMBLY AND ASSEMBLY

Before starting any operation, make sure that the product is not in operation and can not be fed accidentally or accidentally, and that the fans are stopped. The disassembly and the corresponding assembly are extraordinary maintenance operations and must be carried out by qualified personnel.

ELIMINATION

In accordance with the Directive of the European Parliament 2012/19 / EU on waste electrical and electronic equipment (WEEE)".



The crossed-out wheeled bin symbol on the appliance or on the packaging indicates that the product, at the end of its useful life, must be disposed of separately from the other waste to allow proper treatment and recycling. The user must, therefore, deliver free of charge the device, when it reaches the end of its useful life, to the corresponding local centers for selective collection of electrical and electronic waste, or return it to the distributor according to the following modalities:

- For devices of very small size, or with an exterior side of no more than 25 cm, free delivery without obligation of purchase is foreseen in the stores with an area of sale of electrical and electronic devices superior to 400 m². For stores with inferior surfaces, this modality is optional.
- For appliances with dimensions greater than 25 cm, delivery is foreseen in all the points of sale in the 1-for-1 mode, that is, the delivery to the distributor may only be made at the time of purchase of a new equivalent product, in reason of one to one. The adequate selective collection for the subsequent delivery of the discarded device to recycling, treatment and compatible environmental elimination, helps to avoid possible negative effects on the environment and health and favors the reuse and / or recycling of the materials that make up the device. The illegal elimination of the product by the user supposes the application of the sanctions foreseen by the current legislation.

LIFTING AND POSITIONING

The KOXA series air handling units are constructed to be lifted from their base. The base of the units are provided with lifting holes in the corners of the base or along its perimeter. For correct lifting of the machine, if necessary, use the holes along its perimeter, otherwise use the holes in the corners of the unit. For lifting, the weight of each module and its center of gravity must be taken into account, slightly raise the unit to verify its position.

The unit must always be placed on a surface that will support the load of the unit, being flat and level. The place where the unit is to be positioned must have sufficient space to allow the correct opening of the doors of the various sections and allow access for installation and maintenance purposes.

UNION OF THE SECTIONS

The units are often supplied in several sections, the installer having to join the various sections at the installation site.

This operation must be performed using the supplied materials, which can be found inside the unit:

- Apply self-adhesive joint to the aluminum profile of the sections to be joined.
- Tighten the union pieces of sections that are in the profiles of the structure of the sections to be joined.
- Tighten the parts on both sides of the modules.

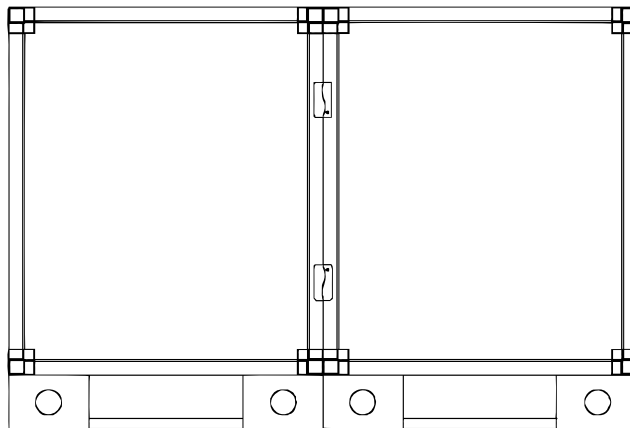

Some sections of the heat recovery unit, due to their size, can be sent partially disassembled. In this cases due attention should be paid to these delicate components, in order to prevent them from being damaged.

Check that the seals and sealing silicones of these elements. In the case of heat recovery units with integrated bypass, make sure that the register works correctly.

CONDENSED TRAY

The condensate tray aims to collect condensates that may appear in the sections where they are placed.

The condensate outlets of the various sections where these are present must be equipped with siphons suitable for:

- Ensure proper drainage of condensates
- Prevent entry of air when unit section is under negative pressure
- Prevent air leakage when the section is under positive pressure.
- Prevent entry of odors and insects.

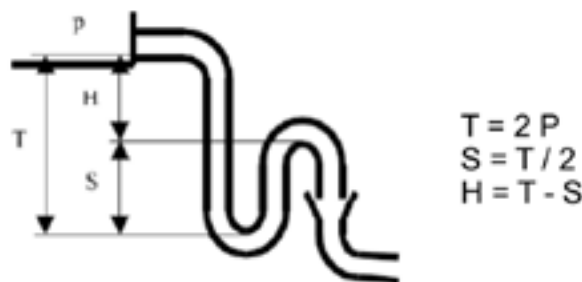

Where P represents the pressure (positive or negative) within the section in mm c.The. The siphon must be allowed to be cleaned for regular maintenance.

KOXA 8000

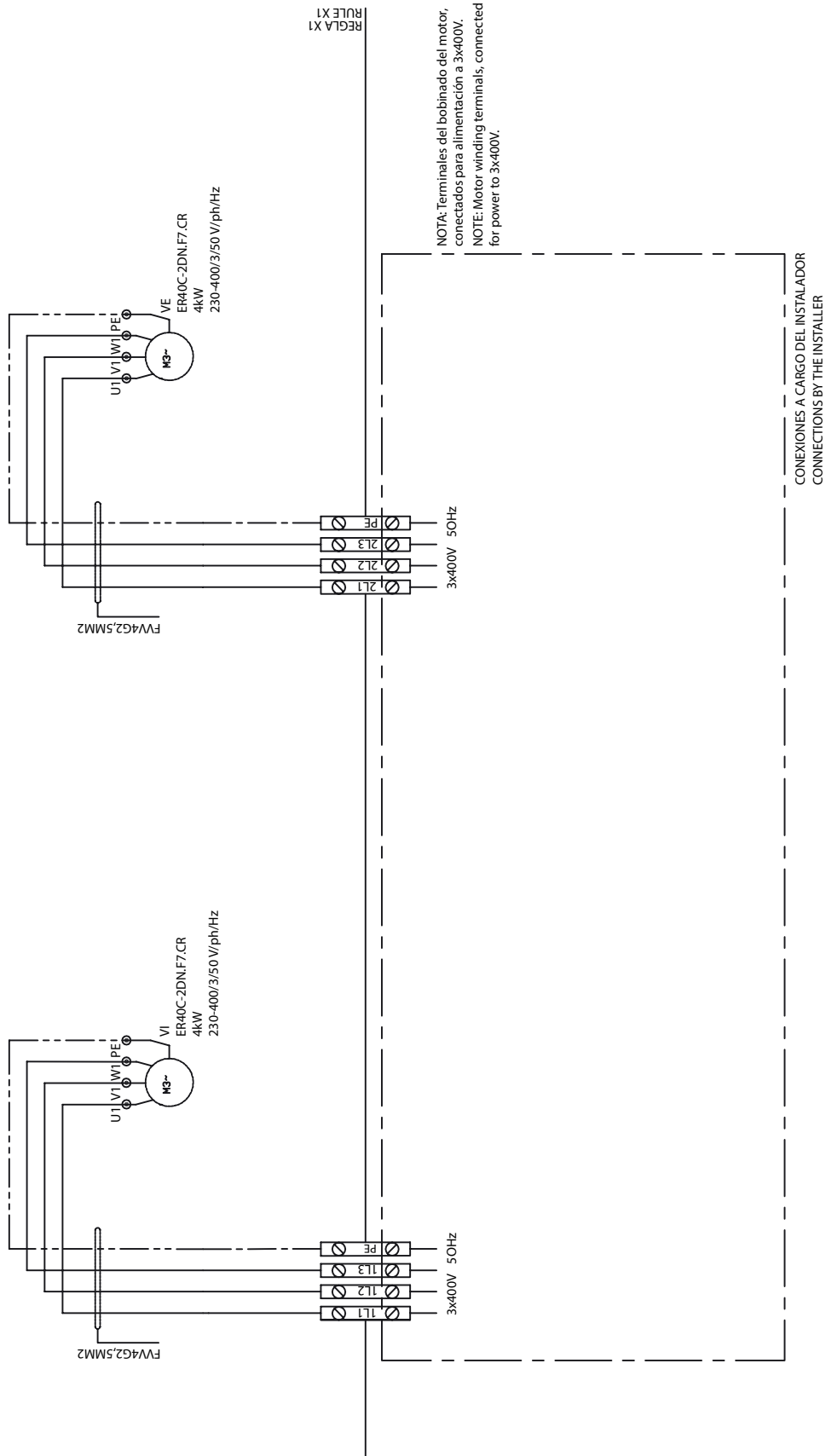

KOXA 12000

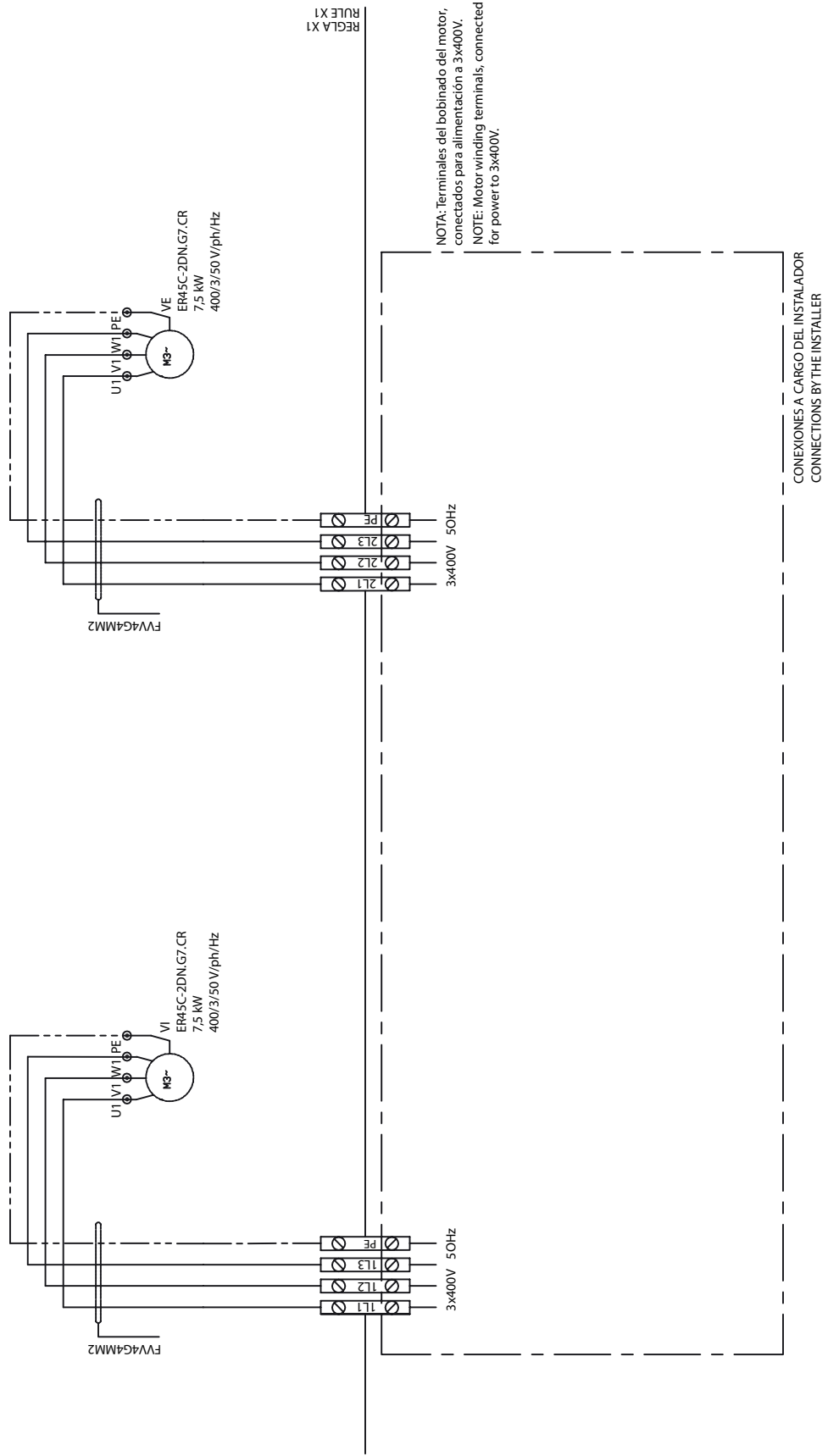

KOXA 14000

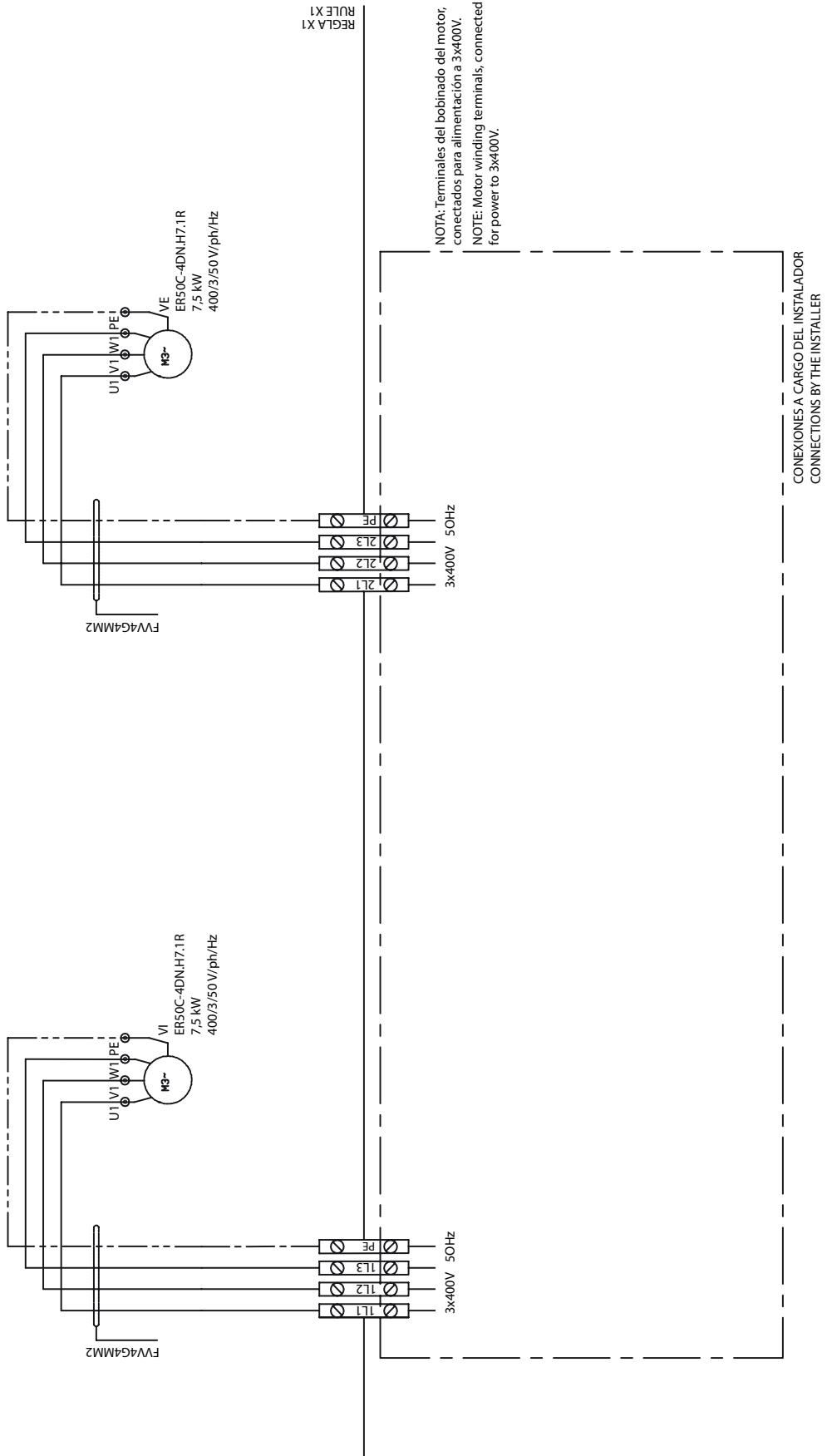

WIRING DIAGRAMS

One of the vital components for the correct operation of the air treatment units of the Casals ventilación brand are the fans, so it must be ensured that they are correctly connected according to the following diagrams:

THREE PHASE RANGE 400V

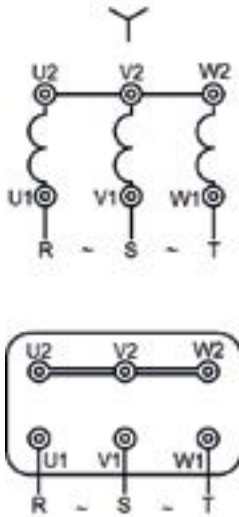

THREE PHASE RANGE 230V

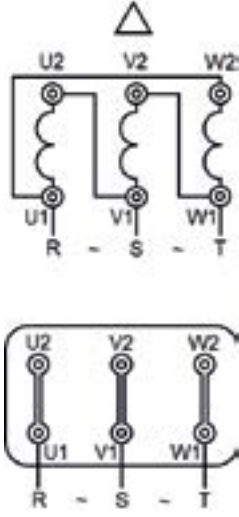

THREE PHASE RANGE 400/690

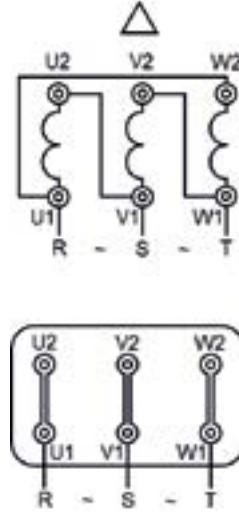

NOTE: For AC fans of two or more speeds consult the manufacturer's manual.

ACCESSORIES - CUTTING SWITCH

The installation of a cut-off switch is of major importance in order to safeguard those who perform safety / maintenance interventions in the ventilation equipment, and is obligatory to comply with the Machinery Directive 2006/42 / EC. Thus Casals ventilació air treatment units can be supplied with mounted cut-off switches. The diagram below shows the connection diagram for the single phase and three phase fans.

SINGLE PHASE RANGE

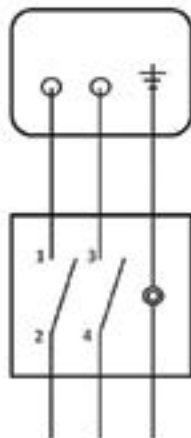

THREE PHASE RANGE

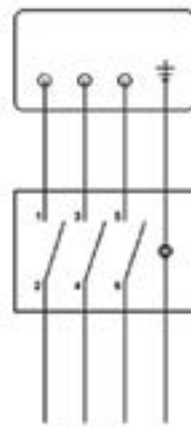

ACCESSORIES - DIFFERENTIAL AIR PRESSURE SWITCH

The differential air pressure switch allows the differential pressure to be monitored between two different points. It is applied to the equipment to collect information about the condition of the filters and also the condition of the fans of the equipment. The desired pressure differential is set directly on the pressure switch as shown with its electrical connections shown.

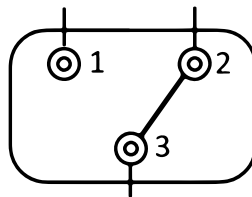
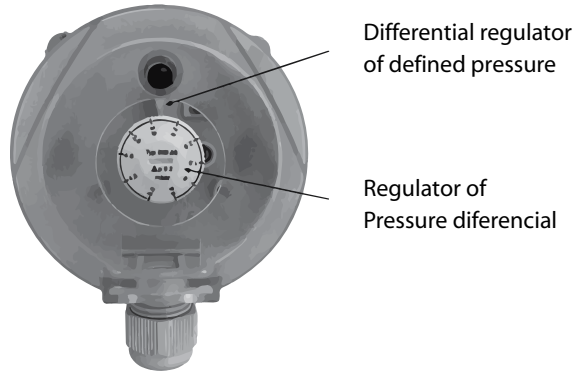

ACCESSORIES - CONSTANT AIR FLOW (AC MOTORS)

The constant air flow accessory allows the flow to be maintained constant regardless of the change in the system pressure drop. Air flow control is performed by using a ratio of the flow of air to the differential pressure switch as shown in the image below for three-phase fans.

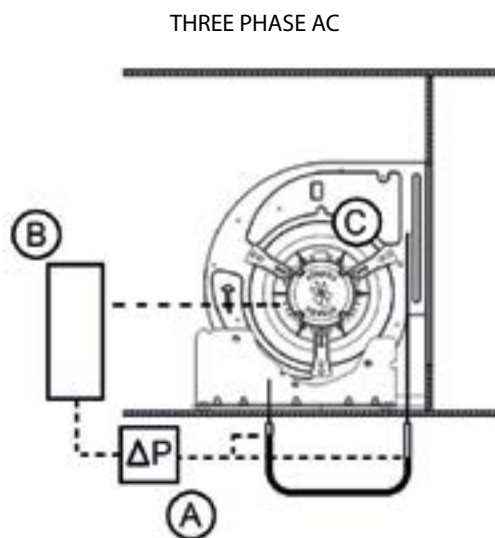

- A - Differential Pressure Sensor
- B - Frequency Inverter
- C - Fan

The system uses a differential pressure sensor and a frequency converter (three-phase fans) or a voltage inverter (single-phase fans). The differential pressure sensor has different operating ranges, and the range of choice depending on the regulation to be performed.

Range of values of differential sensor			
1	2	3	Gamma
8	8	8	0 - 100 Pa
8	8	8	0 - 250 Pa
8	8	8	0 - 500 Pa
8	8	8	0 - 750 Pa
8	8	8	0 - 1,000 Pa (default)
8	8	8	0 - 2,000 Pa
8	8	8	-50 to 50 Pa
8	8	8	-100 to 100 Pa

Constant air flow regulation is performed on the frequency inverter (three-phase fans) or on the inverter (single-phase fans). In the case of the frequency inverter, a percentage value of the selected operating range is selected on the differential pressure sensor and in case of the differential pressure value to be maintained.

For frequency inverters, the adjustment is made as follows:

Access to:

- MENU [FUn-]
- SUBMENU [PI-]
- CATEGORY [rPI]

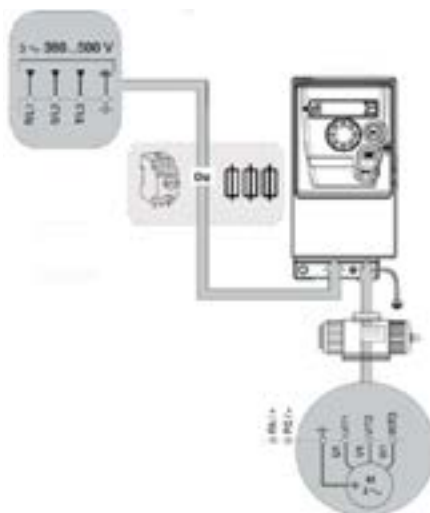

ACCESSORIES - CO₂ CONTROL (AC MOTORS)

The CO₂ control accessory aims to monitor the concentration of carbon dioxide in the air in real time and adjust the fan according to the measured and desired carbon dioxide concentration value.

The system uses a carbon dioxide sensor and a frequency inverter (three phase fans) as shown.

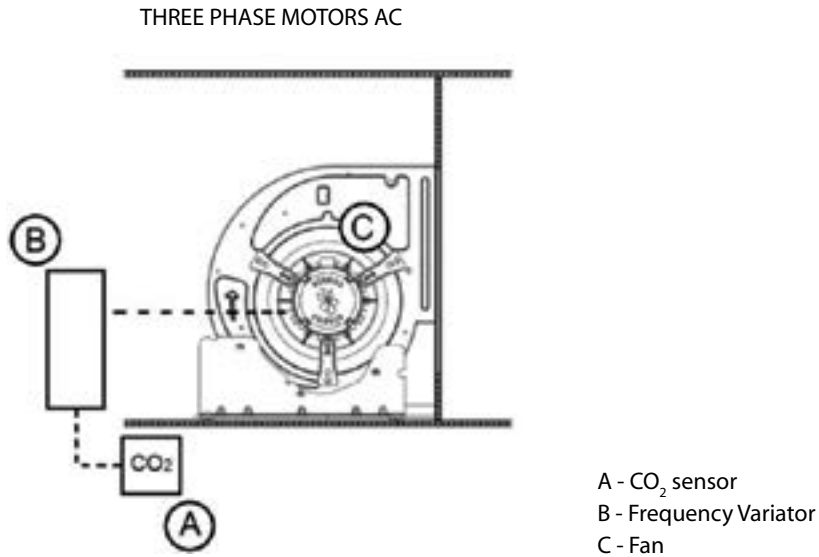

The control of the CO₂ control is performed in the frequency inverter (three-phase fans) or in the inverter (single-phase fans). In the case of the frequency inverter, a percentage value of the sensor reading range and in the case of the inverter the value of the desired carbon dioxide concentration (ppm)

For frequency inverters, the adjustment is made as follows:

Access to:

- MENU [FU_n-]
- SUBMENU [PI-]
- CATEGORY [rPI]

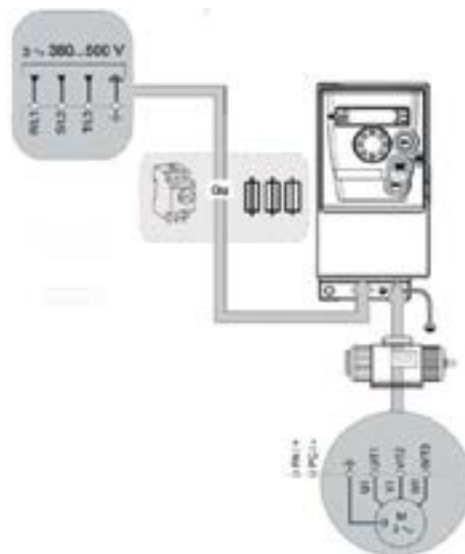

WATER COIL

The Casals ventilación air treatment units can be supplied with a water coil for heating and / or cooling. These coils use the flow of hot and / or cold water for heating and / or cooling.

For correct operation and to avoid damage to the coil, attention must be paid to the following warnings:

- Check limits of water temperatures and water pressure.
- All hydraulic connections must be made in accordance with good art practices.
- A trap must be placed in the highest part of the hydraulic circuit.
- A filter must exist in the hydraulic installation.

DIRECT EXPANSION COIL

Casals ventilación air handling units can be supplied with direct expansion coil that can be used for heating or cooling. These coils use the flow of a refrigerant to transfer heat to the air.

For proper operation and to avoid damaging the coil, the following warnings must be observed:

- The coils are designed to use only the selected refrigerant.
- The installation of these coils must be done by a qualified technician for the service.
- Ensure that working fluid pressure is within acceptable values.
- This coil should be installed with condensate tray and condensate drain to remove excess fluid from the unit.

ELECTRICAL COIL

Casals ventilación air handling units can be supplied with electric coil. These coils use electrical heating resistors. Three-phase power supply is shown below the respective wiring diagrams.

- Electrical coil of 1 stage:

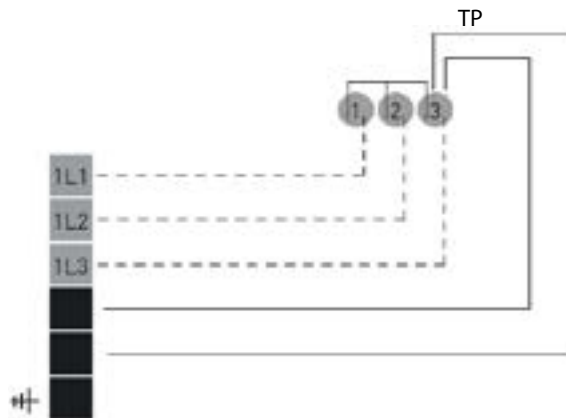

- Electrical coil of 2 stage:

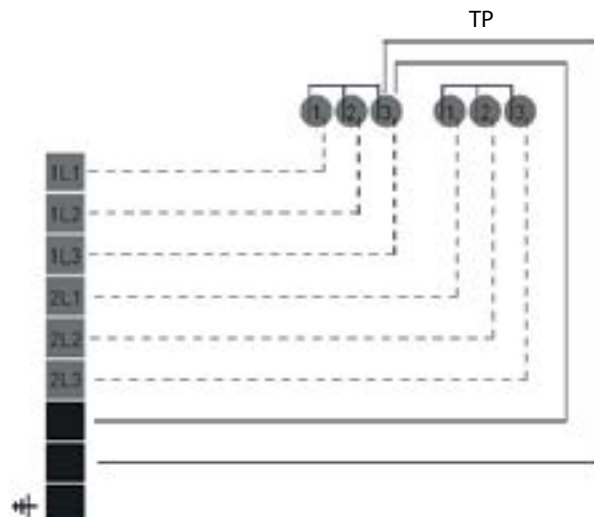

TP- Thermal protection (Safety thermostat)

- Electrical coil of 3 stage:

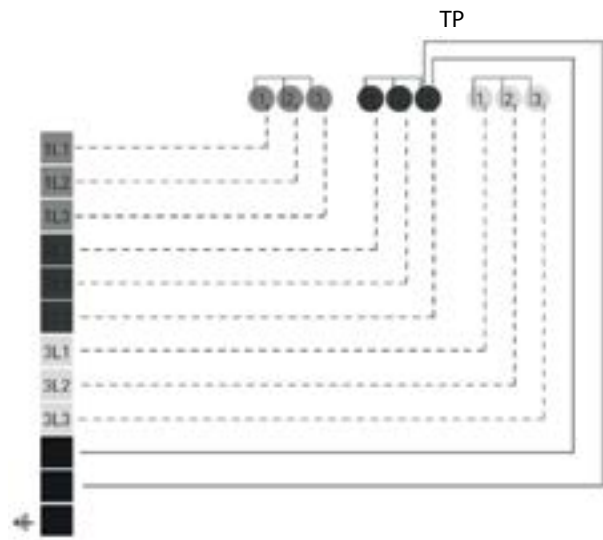

- Electrical coil of 4 stage:

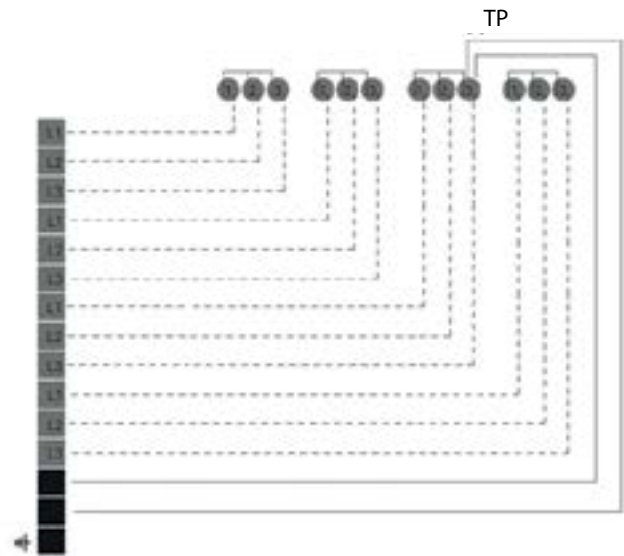

- Electrical coil of 5 stage:

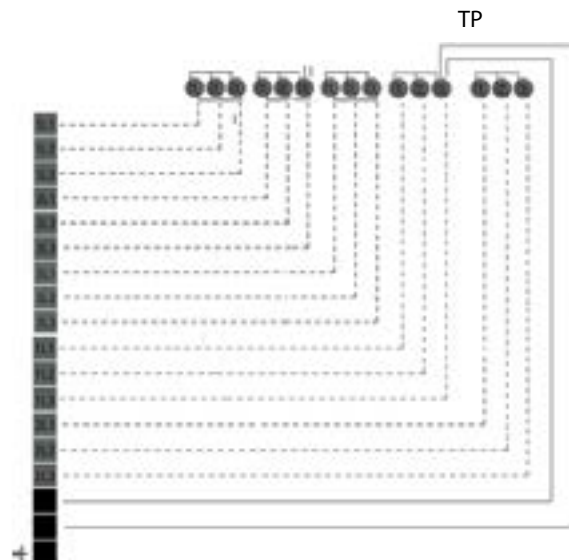

TP- Thermal protection (Safety thermostat)

- Electrical coil of 6 stage:

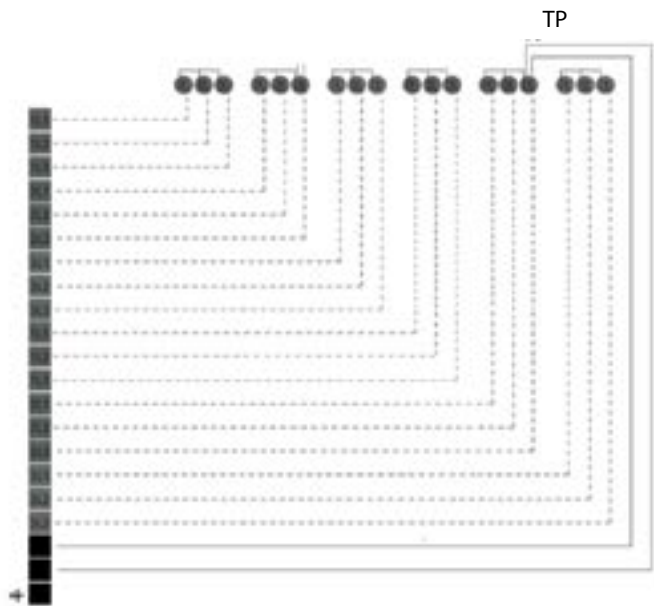

TP- Thermal protection (Safety thermostat)

TROUBLESHOOTING

Problem	Possible Cause	Check	Possible Solution
Motor very high consumption	Different operating point than expected;	Check the flow rate and pressure drop;	Reduce rotation speed;
	Excess flow;	Fan speed;	Create a loss of load in the installation;
Excess air flow	Air distribution system, loss of load in the overcrowded installation;	Check the flow rate and pressure drop; Fan speed;	Reduce rotation speed; Create a loss of load in the installation;
Insufficient flow rate	Air distribution system, underestimate installation pressure drop;	Check flow and pressure drop; Fan speed;	Increase the speed of rotation (according to available motor power and maximum fan speed);
Excessive noise	Flow too high, too high throughput; Load too high;	Check the flow rate and pressure drop;	Decrease flow rate; Avoid areas of unstable operation of the fan;
	Damaged bearings, damaged metal components; Unbalanced moving components;	Bearings, state of the components; Strange vibrations;	Replace bearings, damaged components; Calibrate / Replace fan;
Drive does not work	Power failure;	Power supply; Circuit breaker;	Restore power supply; Resetting circuit breaker;
Low coil performance	Reduced operating fluid flow	Check intake flow	Check intake flow
Low efficiency of the unit	Dirt of improper recovery element	Cleaning state of the heat exchanger	Clean unit

Note:
Please note that air handling units are integrated into a general system. For this reason, failures may be caused by other components of the system, incorrect interaction between the unit and the system, or environmental conditions other than the specificities for the design of the unit

CE DECLARATION OF CONFORMITY

We hereby declare, under our only responsibility, that the CASALS brand products described in this manual comply with the directives 2014/35/EU (Low Voltage), 2006/42/EC (Machinery), 2014/30/EU (Electromagnetic compatibility), 2009/125/EC* (Ecodesign) and with all the standards mentioned in this instruction manual.

*The compliance of this Directive only affects to ErP marked compliant models.

VENTILACIÓN INDUSTRIAL IND S.L.

Crta. Camprodon, s/n
17860 Sant Joan de les Abadesses (Girona)
GPS: N 42° 14' 10", E 2° 17' 40"
Tel. (+34) 972720150
Fax (+34) 972721053
E-mail nacional: ventilacion@casals.tv
E-mail export: fans@casals.tv
www.casals.tv

Sr. David Samper
Dir. General



Sant Joan de les Abadesses 02/07/2018