

DOMEX EEC

USER MANUAL AND INSTALLATION



INDEX

SECURITY RULES AND MARKING CE	p.3
GENERAL RULES	p.3
MAINTENANCE	p.3
EQUIPMENT WARRANTY	p.3
CONDITIONS OF INSTALLATION	p.5
RESIDUAL RISKS	p.5
SIGNALS PLACED ON THE MACHINE	p.5
- Prohibition signs	
- warning information signs	
- identification signs	
RECEPTION OF THE MERCHANDISE	p.6
DISPLACEMENT	p.6
STORAGE	p.6
PROLONGED STOP	p.6
START UP	p.6
ASSEMBLY AND DISASSEMBLY	p.6
ELIMINATION	p.6
CONFIGURATION	p.7
CONDENSED TRAY	p.7
WIRING DIAGRAMS	p.8
ACCESSORIES- CUTTING SWITCH	p.11
ACCESSORIES- PRESSOSTAT	p.11
ACCESSORIES- CONSTANT FLOW	p.12
ACCESSORIES- CO ₂ CONTROL	p.13
ACCESSORIES- WATER COIL	p.14
ACCESSORIES- ELECTRICAL COIL	p.14
TROUBLESHOOTING	p.16
DECLARATION OF CONFORMITY	p.17

DOMEX EEC

SECURITY AND MARKING STANDARDS "CE"

Our R & D department is concerned with achieving efficient products in compliance with the current "safety standards". The rules and recommendations set out below mainly reflect what is in effect in safety material and therefore are mainly based on compliance with the general rules. Therefore, we strongly recommend all the people who manipulate the machine to follow the rules of accident prevention in their place and in their country. Casals ventilation is exempt from any liability for any damage caused to people or property arising from non-compliance with safety regulations, as well as any changes made to the product.

The CE marking and the relative declaration of conformity certify compliance with applicable Community standards. Products that are not marked on the CE plate must be completed by the buyer who must then certify the entire plant, thus providing the certificate of conformity.

The machines meet the requirements of:

- Machinery Directive 2006/42 / CE.
- Low voltage directive 2014/35 / CE.
- With the Electromagnetic Compatibility Directive 2014/30 / CE.
- Ecodesign Directive 2009/125 / CE.

GENERAL RULES

Safety guards should not be removed if it is not due to absolute need for work; in which case appropriate measures must be taken that must be taken immediately in the event of possible danger.

All maintenance work (ordinary and extraordinary) must be carried out with the machine stopped, electrical power, pneumatic etc ... disconnected. To avoid the danger of accidental insertion, stick on electrical panels, control units and control consoles warning signs with the words "Warning: command excluded for maintenance in progress". Before connecting the power cable to the terminal board verify that the line voltage is suitable for that shown on the machine's plate, pay attention to the labels placed on the product; if time goes by they should become illegible and they would have to be replaced.

The device must not be used by people (including children) whose physical, sensory or mental abilities are reduced, or with lack of experience or knowledge, unless they have been able to benefit, through the intermediation of a responsible person in their security, surveillance or instructions on the use of the device. Children should be checked to prevent them from playing with the device.

MAINTENANCE

The maintenance staff, in addition to having to observe the current legal provisions on accident prevention, must comply with the instructions shown below:

- Wear appropriate safety clothing.
- Use soundproof headphones when the noise exceeds the allowed limit.
- Verify the existence of an interlock that foresees the start-up of the machine by other people.

These heat recovery systems lack the maintenance periodically to perform correctly the function for which they were designed. The frequency with which maintenance is performed depends on the characteristics of the environment in which the device is inserted and the number of hours of operation, so what is indicated below should be seen as guidance.

Fan

Operations to be carried out:

- Check if there are no foreign bodies inside the module.
- Check that all screws are tightened to avoid unwanted vibrations.
- General interior cleaning.

Maintenance interval: half-yearly

Filters

Operations to be carried out:

- Check if there are no foreign bodies inside the module.
- Check that all screws are tightened to avoid unwanted vibrations.
- Check if there are no cuts in the filter mat.
- Check the clogging status of the filters (clean or replace if necessary).
- General interior cleaning.

Maintenance frequency: monthly

Heat recovery

Operations to be carried out:

- Check if there are no foreign bodies inside the module.
- Check that all screws are tightened to avoid unwanted vibrations.
- Check the condition and fixing and cleaning of the recovery element.
- General interior cleaning.

Maintenance interval: half-yearly

Water coil

Operations to be carried out:

- Check if there are no foreign bodies inside the module.
- Check that all screws are tightened to avoid unwanted vibrations.
- Check the connections to the battery.
- Check and clean (if necessary and with care not to cause damage) the fins of the batteries.
- If there are deformed fins, place them in the correct position with a suitable "comb".
- General interior cleaning

Maintenance frequency: annual

Electric coil

- Check if there are no foreign bodies inside the module.
- Check that all screws are tightened to avoid unwanted vibrations.
- Check the state of the connections, replacing and re-making connections if necessary.
- General interior cleaning.

Maintenance interval: half-yearly

EQUIPMENT WARRANTY

Casals Ventilation warrants this product against all manufacturing defects for a period of two (2) years from the date of purchase.

The service under warranty, will only be paid by presenting the purchase receipt, which shows that the machine is within the warranty period. If, during the guarantee period, the product resulting from recognizing the problems of manufacturing defects, Casals ventilation or its authorized technical services, shall, to the free repair on site or (according to the criteria of Casals ventilation) to replace the product or make available to the customer for the replacement of defective components according to the following conditions. Casals ventilation reserves the right, (at its own discretion) to replace the components of defective products or low-value products, both components or new products, such as components or recycled products.

Warranty exclusions

- Pieces of natural wear.
- Parts subject to deterioration or breaking, for example belts, filters, fuses, etc.
- Failures caused by misuse, neglect, negligence, atmospheric discharges, floods, humidities, falls, crashes, accidents and transportation.
- Failures caused due to the use of equipment for purposes other than those foreseen.

Failures caused as a result of manipulation, change or repair of equipment by unauthorized persons or technical services or due to the use of inappropriate parts or accessories.

Faults caused due to incorrect or illegal installation (voltage, water pressure or other), power anomalies, non-compliance with the instructions.

- Wear or aesthetic deterioration, resulting from the use, changes in tones, oxidation or corrosion of the device or its components.
- A possible repair does not result in the continuation of the warranty nor will it entitle any compensation.

The guarantee does not apply every time ...

- The type plate of the equipment is tampered with or tampered with.
- False data is provided.
- Do not accompany the equipment with the purchase document.
- The equipment is manipulated, changed or repaired by unauthorized persons or technical services.
- Verification / maintenance operations are not carried out or are carried out by unauthorized technicians.

CONDITIONS OF INSTALLATION

The installation inside or outside buildings with an ambient temperature between -15 ° and + 50 ° C

It should be avoided:

- Areas near heat sources, steam, gas or flammable liquids and / or explosives, especially dusty areas, proximity to water sources such as tanks, showers or swimming pools. Do not touch the appliance with wet or damp hands or feet. Do not leave the device exposed to atmospheric agents.

Must be:

- Use the device only for the use for which it has been expressly manufactured. The manufacturer is not liable for possible damages arising from improper or incorrect uses.
- Consider an area where the air drive and the noise of the unit do not cause discomfort to neighbors.
- Consider a position that respects the minimum spaces (as indicated in this manual).
- Consider a position that does not obstruct steps or entries.
- The degree of protection of the unit is IP20.

In case of installation abroad:





- Place the unit in a place protected from atmospheric agents.
- Use the corresponding rain protection cover (if necessary together with the corresponding protection hoods with net). In this case, the degree of protection becomes IP22.

RESIDUAL RISKS

The risk analysis of the products has been carried out according to the Machinery Directive (Annex I of Directive 2006/42 / EC). This manual contains the information for all the exposed personnel in order to prevent possible damages to people and / or things due to residual risks.

SIGNALS PLACED ON THE MACHINE

Various signaling pictograms may be present on the machine, which must not be removed. This signals are divided into:

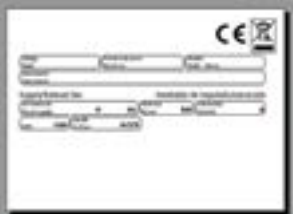
- PROHIBITION SIGNALS	
- Do not repair or adjust during motion.	
- DANGER AND INFORMATION SIGNALS	
- Attention to the presence of electric current.	
- Automatic start Danger.	
- Attention to the instruction manual.	
- Grounding the machine.	
- PRODUCT MARKING	
	

RECEPTION OF THE MERCHANDISE

Each product is checked carefully before shipment. At the time of reception, check that the product has not been damaged during transport; otherwise, communicate the incident to the carrier. The carrier is responsible for possible damages derived from transportation. The products are packed in pallets and fixed to it by strips and protective film, or in self-supporting cardboard boxes, properly fixed to the pallet.

DISPLACEMENT

Before moving the product, make sure that the medium used has adequate capacity. For lifting, use forklifts, lifting the pallet. The maximum hand lift is specified in the 89/391 / EEC standard and later. It is generally acceptable a weight of 20 kg below the back but above ground level.

STORAGE

Store the unit in a sheltered place, without excessive humidity and not subject to strong temperature fluctuations, in order to avoid the formation of condensation inside the unit. Storage is not recommended for a period longer than one year. If more than one year is stored, it is necessary to check the free rotation of the bearings before installation (turn the turbine by hand).

PROLONGED STOP

In case of prolonged shutdown, with the unit connected to the ventilation system, close the suction / discharge ducts and periodically check the absence of humidity inside the machine. In case of moisture formation, dry it immediately.

START UP

Before commissioning, it is advisable to carry out some checks (follow the safety instructions set out in the DISMOUNTING AND ASSEMBLY section):

- Make sure that there is no condensation inside the unit, and if necessary dry it before putting the unit into operation.
- Check the status of the filters.
- Make sure that the interior of the product has no foreign bodies and that all the components are fixed in their seats.
- Manually test that the turbine does not rub against the suction mouth of the machine.
- Check that the inspection gate is closed.

ATTENTION:

If the mouths of a fan are not properly holed, a suitable protection net must be provided. Check the electrical ground connection. The electrical connection must be made by qualified personnel.

DISASSEMBLY AND ASSEMBLY

Before starting any operation, make sure that the product is not in operation and can not be fed accidentally or accidentally, and that the fans are stopped. The disassembly and the corresponding assembly are extraordinary maintenance operations and must be carried out by qualified personnel.

ELIMINATION

In accordance with the Directive of the European Parliament 2012/19 / EU on waste electrical and electronic equipment (WEEE)".



The crossed-out wheeled bin symbol on the appliance or on the packaging indicates that the product, at the end of its useful life, must be disposed of separately from the other waste to allow proper treatment and recycling. The user must, therefore, deliver free of charge the device, when it reaches the end of its useful life, to the corresponding local centers for selective collection of electrical and electronic waste, or return it to the distributor according to the following modalities:

- For devices of very small size, or with an exterior side of no more than 25 cm, free delivery without obligation of purchase is foreseen in the stores with an area of sale of electrical and electronic devices superior to 400 m². For stores with inferior surfaces, this modality is optional.
- For appliances with dimensions greater than 25 cm, delivery is foreseen in all the points of sale in the 1-for-1 mode, that is, the delivery to the distributor may only be made at the time of purchase of a new equivalent product, in reason of one to one. The adequate selective collection for the subsequent delivery of the discarded device to recycling, treatment and compatible environmental elimination, helps to avoid possible negative effects on the environment and health and favors the reuse and / or recycling of the materials that make up the device. The illegal elimination of the product by the user supposes the application of the sanctions foreseen by the current legislation.

CONFIGURATIONS

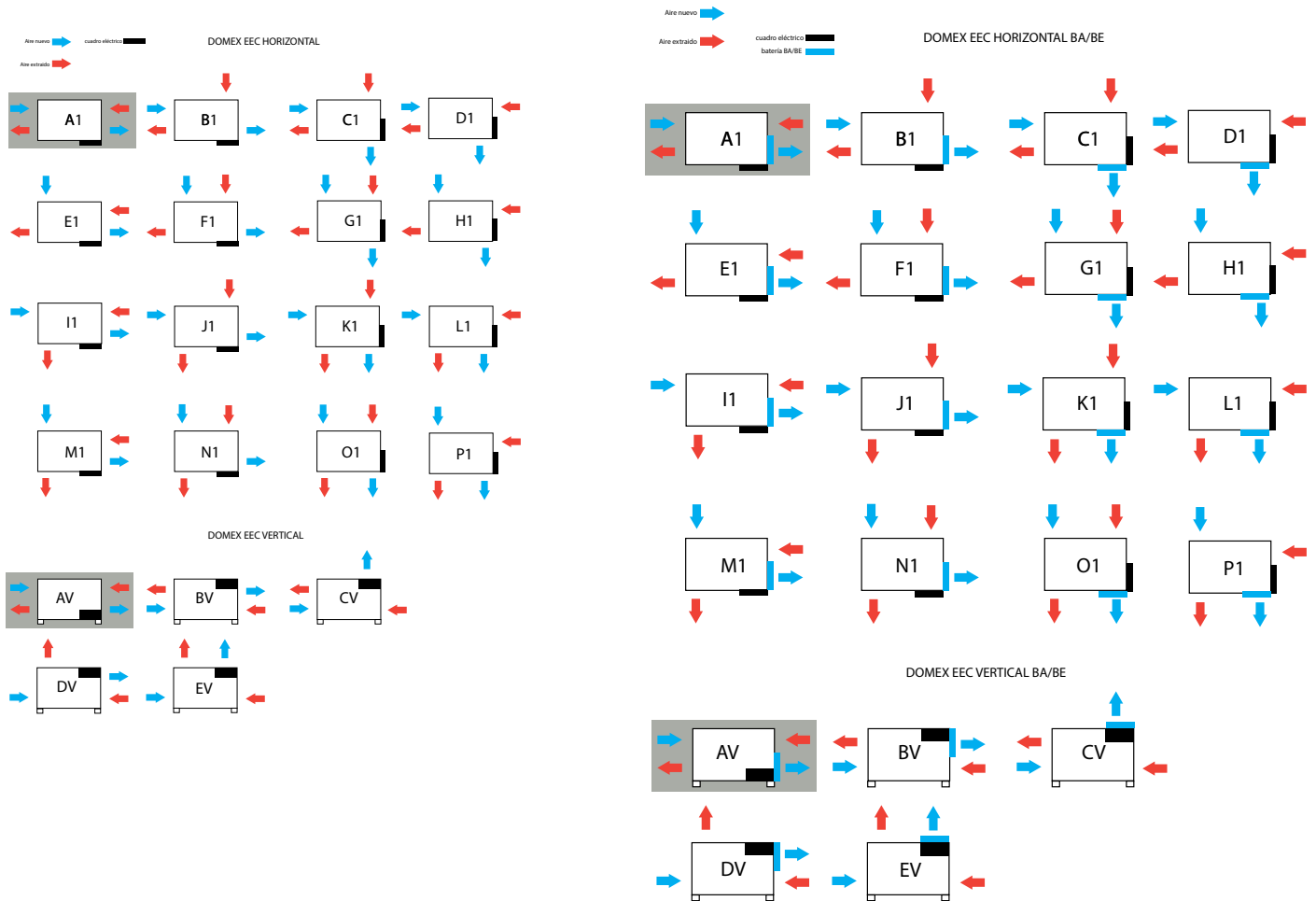

CONDENSED TRAY

The condensate tray is designed to collect condensates that may be present in the unit. Although the tray is already mounted in the recovery unit, the sewage outlet is supplied separately and is required to be installed at the installation site. For a correct installation of the sewer pipe, follow the instructions.

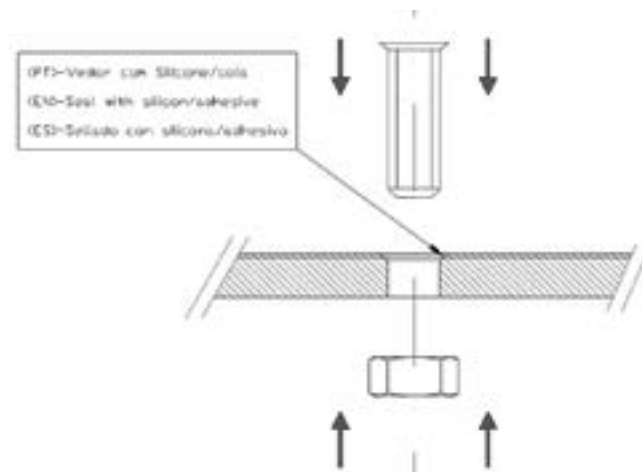

Note: A properly configured siphon must be placed to ensure proper drainage of condensate and to avoid any bad odors

Connection by the installer

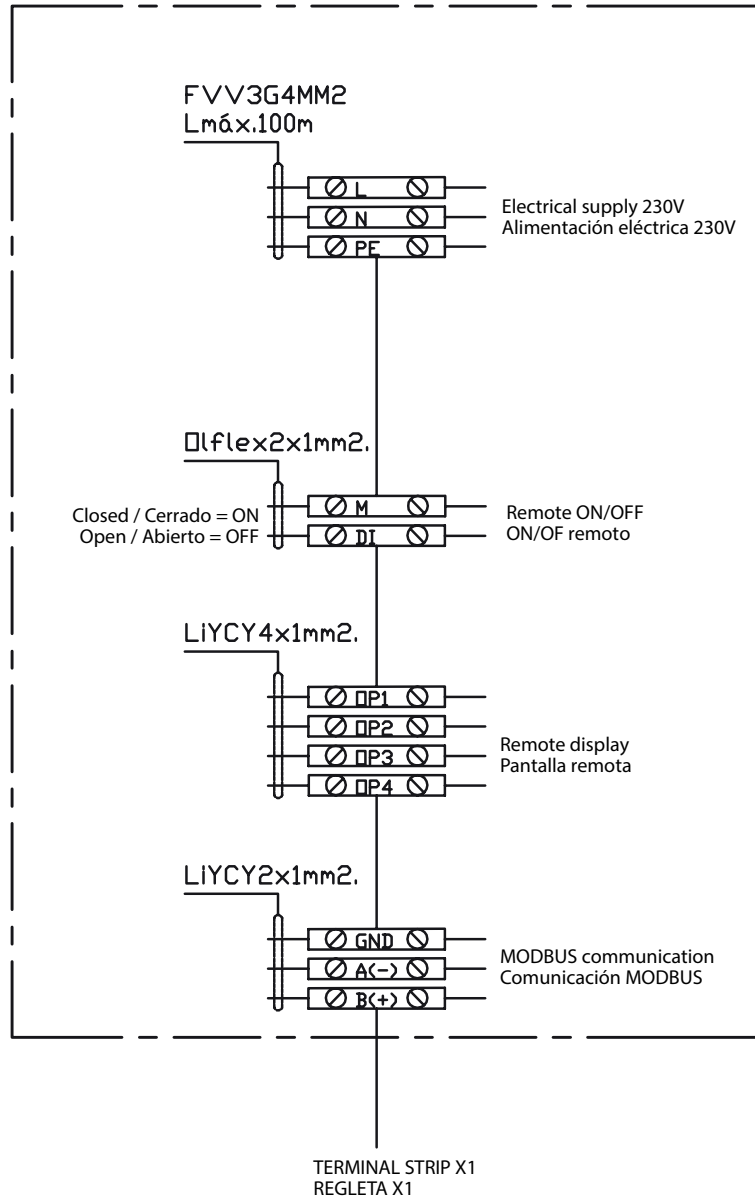

- DOMEX 1000 EEC

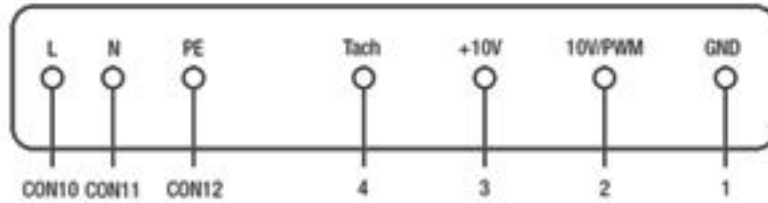

Line	Connection	Color	Function
CON10	L	Black	Power supply - Phase
CON11	N	Blue	Power supply - Neutral
CON12	PE	Green/yellow	Grounding
1	GND	Blue	GND - Connection for control interface
2	0-10V/PWM	Yellow	Control input 0 - 10V or PWM
3	+10V	Red	10V voltage output
4	Tach	White	Output tachometer: Open collector, 1 pulse per rotation

- DOMEX 1600/23000 EEC

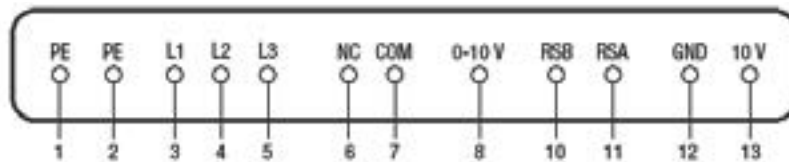

Line	N°	Connection	Color	Function
1	1,2	PE	Green/yellow	Grounding
1	3,4,5	L1, L2, L3	Black	Power supply, see characteristics on the motor plate
1	6	NC	White	State relay, normally open, date with alarm
1	7	COM	White	Status relay (2A, 250V, min. 10mA, AC1)
2	8	0-10V	Yellow	Analog input 0-10V, 100 KΩ impedance
2	10	RSB	Brown	MODBUS (RS-485)
2	11	RSA	White	MODBUS (RS-485)
2	12	GND	Blue	Reference for interface
2	13	+10V	Red	Power supply for external devices, max. 10mA

- DOMEX 3900 EEC

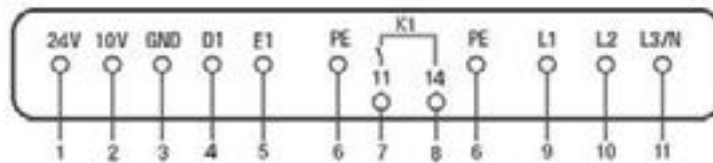

Nº.	Connection	Function
1	24V	Output voltage 24VDC- I _{max} = 70mA
2	10V	Output voltage 10VDC- I _{max} = 10mA
3	GND	ND - Connection for control interface
4	D1	Digital entry 1
5	E1	Analog input 1(control 0-10V)
6	PE	Ground
7	11	State relay, normally open, date with alarm
8	14	(2A, 250VAC)
9	L1	Power supply - phase
10	L2	Power supply - phase
11	L3/N	Power supply - phase/neutral

- DOMEX 5400 EEC

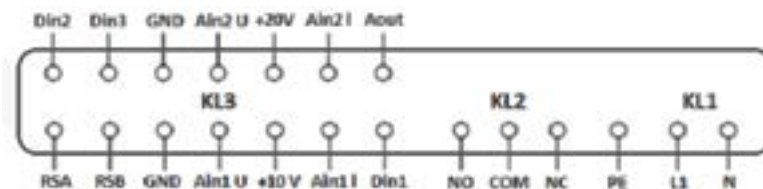

Conector	Connection	Description
KL1	L1	Power supply
	L2	
	L3	
PE	PE	Grounding
KL2	NO	State relay normally open, date with alarm
	COM	Status relay
	NC	State roll, normally dated, open with alarm

Conector	Connection	Description
KL3	RSA	MODBUS (RS-485)
	RSB	
	GND	
	Ain1U	Analog input 0-10V, 100 KΩ impedance
	+10V	Power supply for external devices, max. 10mA
	Ain1I	Analog input 4-20mA, 100 KΩ impedance
	Din1	Digital input 1
	Din2	Digital input 2
	Din3	Digital input 3
	Ain2 U	Analog input 0-10V, 100 KΩ impedance
	+20V	Power supply for external devices, max. 50mA
	Ain2 I	Analog input (value definition) 4-20mA, 100 KΩ impedance
	Aout	Analog output 0-10V

ACCESSORIES - CUTTING SWITCH

The installation of a cut-off switch is of major importance in order to safeguard those who perform safety / maintenance interventions in ventilation equipment, and is obligatory to comply with the Machinery Directive 2006/42 / EC. Thus Casals ventilació air treatment units can be supplied with mounted cut-off switches. The diagram below shows the connection diagram for the single phase and three phase fans.

SINGLE PHASE CUT SWITCH

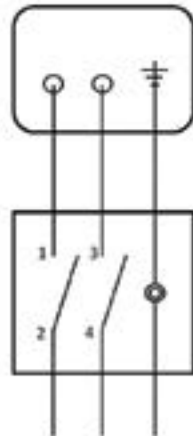

THREE PHASE CUT SWITCH

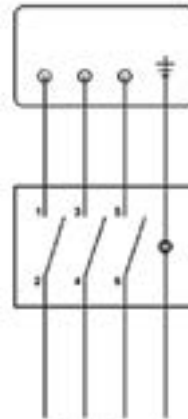

ACCESSORIES - PRESSOSTAT

The differential air pressure switch allows the differential pressure to be monitored between two different points. It is applied to the equipment to collect information about the condition of the filters and also the condition of the fans of the equipment. The desired pressure differential is set directly on the pressure switch as shown with its electrical connections shown.

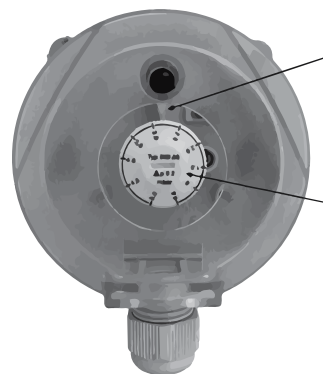

Differential regulator of defined pressure

Regulator of Pressure diferencial

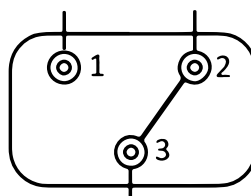

ACCESSORIES - CONSTANT FLOW

The purchased unit can be supplied with the flow meter, thereby allowing a control to maintain constant flow regardless of whether the pressure drop may vary. Flow control is performed using a proportional ratio between the effective flow rate of the fan with the pressure differential between the fan, high pressure, and the following section, low pressure. The operating point of the equipment is set directly on the flow controller

DOMEX EEC

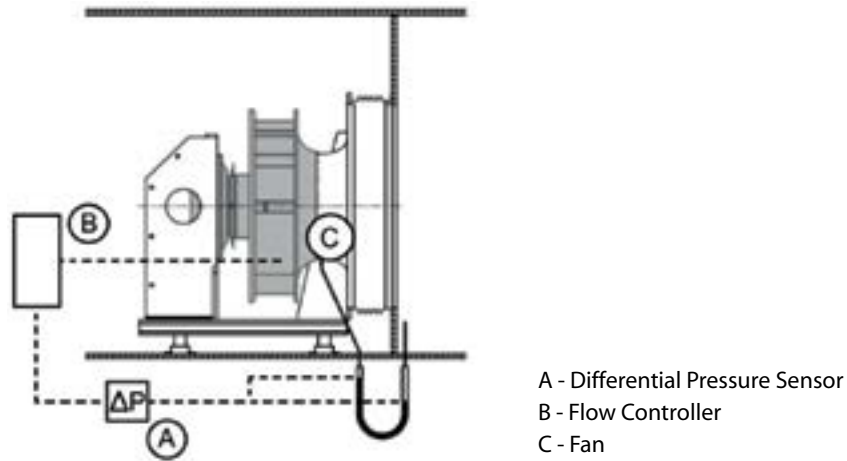

The system uses a differential pressure sensor and a flow controller. The differential pressure sensor has different operating ranges, the chosen range depending on the setting to be made.

Range of values of the SPS differential sensor	
1 2 3	Gamma
8 8 8	0 - 100 Pa
8 8 8	0 - 250 Pa
8 8 8	0 - 500 Pa
8 8 8	0 - 750 Pa
8 8 8	0 - 1,000 Pa (default)
8 8 8	0 - 2,000 Pa
8 8 8	-50 to 50 Pa
8 8 8	-100 to 100 Pa

Constant flow regulation is performed on the flow controller, setting a percentage value of the selected operating range on the differential pressure sensor.

For proper adjustment, follow these steps: Limit fan operation range (JP1 1-2; 2-3)

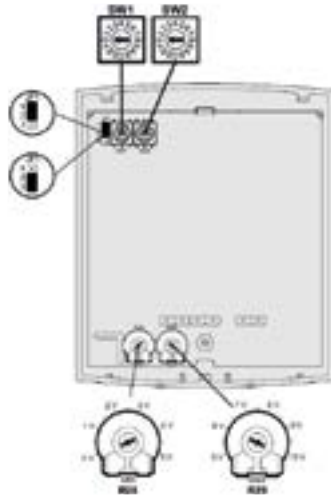

Configure SW1. In this place, the value of the desired configuration is imposed.

SW1	setpoint (5-95%)	SW1	0	1	2	3	4	5	6	7
		setpoint (%)	5	10	20	25	30	35	40	45
		SW1	8	9	A	B	C	D	E	F
		setpoint (%)	50	55	60	65	70	80	90	95
SW2	Proportional band (1-300%)									
JP1 closed(1-2)	Reverse action									
JP1 closed(2-3)	Direct action									
R28	Minimum fan speed limit EEC									
R29	Maximum fan speed limit EEC									

ACCESSORIES - CO₂ CONTROL

The CO₂ control function aims to monitor the concentration of carbon dioxide in the air in real time and make an automatic adjustment of the fan speed according to a defined operating point. This operating point is adjusted CO₂ controller on a scale of 0% and 100%.

DOMEX EEC

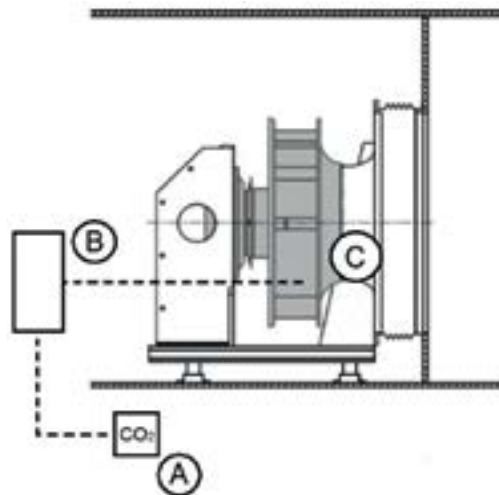

- A - CO₂ sensor
- B - CO₂ controller
- C - Fan

The regulation of the CO₂ control is performed in the CO₂ controller, this being a percentage value of the reading range of the sensor relative to the desired carbon dioxide (ppm) concentration.

For proper adjustment, follow these steps : Limit fan operating range (JP1 1-2; 2-3)

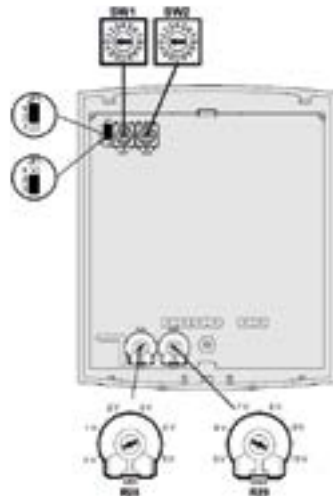

Set SW1 (desired setpoint according to picture 15) In this place, the value of the desired setting is imposed.

7SW1	setpoint (5-95%)	SW1	0	1	2	3	4	5	6	7
		setpoint (%)	5	10	20	25	30	35	40	45
	setpoint (%)	SW1	8	9	A	B	C	D	E	F
		setpoint (%)	50	55	60	65	70	80	90	95
SW2	Proportional band (1-300%)									
JP1 fechado(1-2)	Reverse action									
JP1 fechado(2-3)	Direct action									
R28	Minimum fan speed limit EEC									
R29	Maximum fan speed limit EEC									

ACCESSORIES - WATER COIL

The heating water coil module uses the hot water flow for heating the airflow.

For proper operation and to avoid damaging the coil, the following warnings must be observed:

- The battery should only be used for heating.
- Check limits of water temperatures and water pressure.
- All hydraulic connections must be made in accordance with good practice in the art.
- A trap must be placed in the upper part of the hydraulic circuit.
- There must be a filter in the hydraulic system.

ACCESSORIES - ELECTRICAL COIL

The electric coil module uses electrical heating resistors. They are of three-phase power and are shown below the respective wiring diagrams.

For proper operation and to avoid damaging the coil, the following warnings must be observed:

- Make sure that the safety thermostat is properly installed.
- All connections should be made in accordance with good art practice.

- DOMEX 1000 EEC 6kW

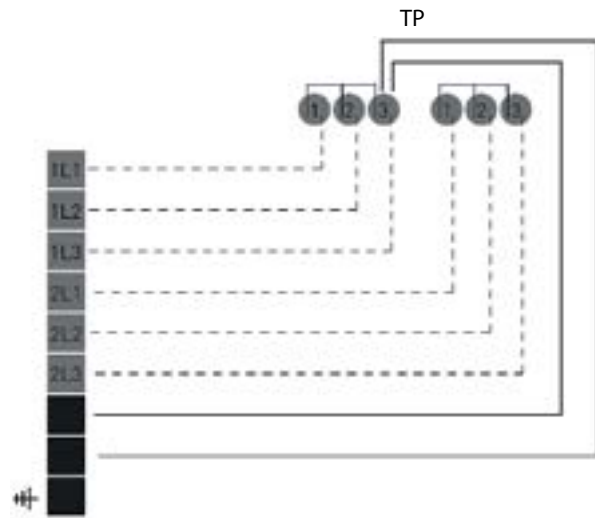

- DOMEX 1600/2300 EEC 12kW

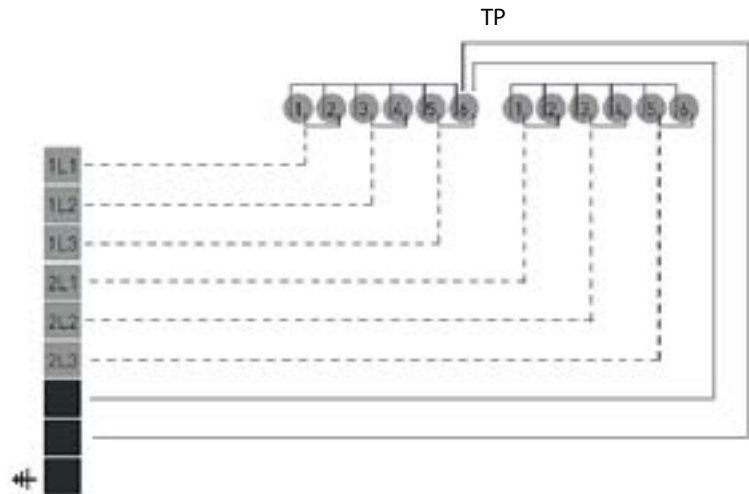

- DOMEX 3900 EEC 18kW

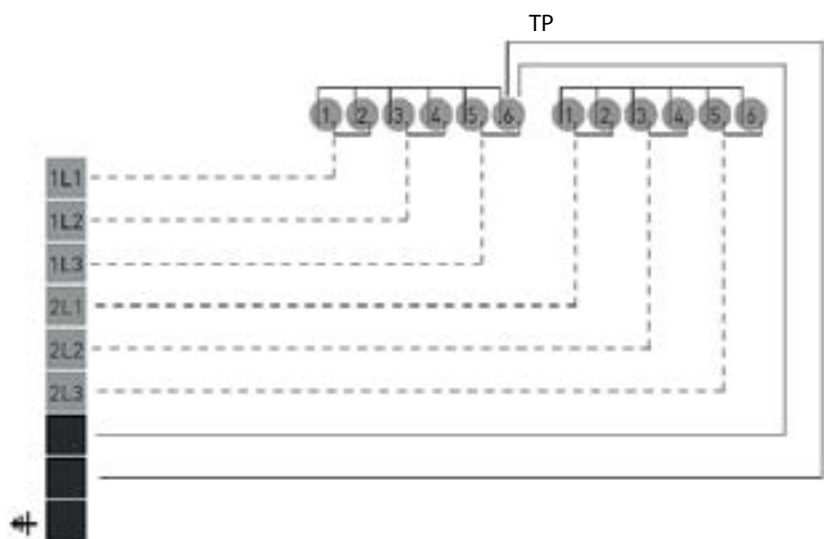

TP- Thermal protection (Safety thermostat)

- DOMEX 5400 EEC 27kW

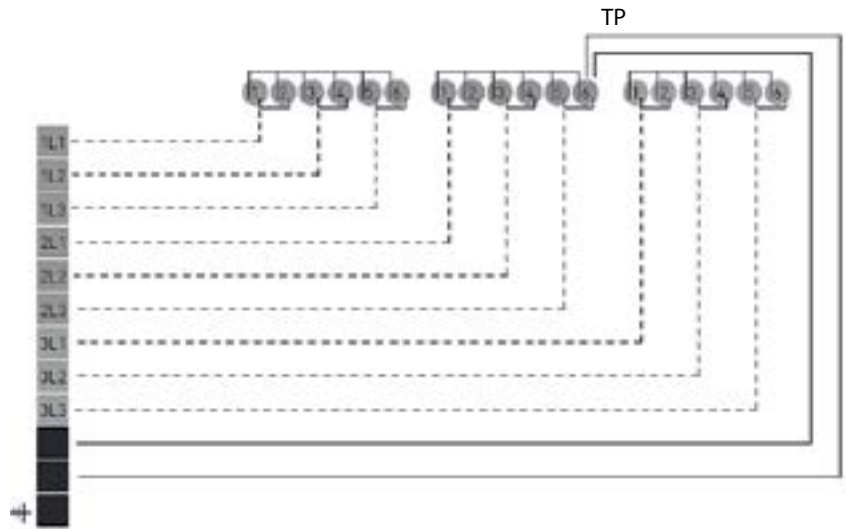

TP- Thermal protection (Safety thermostat)

TROUBLESHOOTING

Problem	Possible Cause	Check	Possible Solution
Motor working at a very high consumption	Different operating point than expected;	Check the flow rate and pressure drop;	Reduce rotation speed;
	Excess flow;	Fan speed;	Create a loss of load in the installation;
Excess air flow	Air distribution system, loss of load in the overcrowded installation;	Check the flow rate and pressure drop; Fan speed;	Reduce rotation speed; Create a loss of load in the installation;
Insufficient flow rate	Air distribution system, underestimate installation pressure drop;	Check flow and pressure drop; Fan speed;	Increase the speed of rotation (according to available motor power and maximum fan speed);
Excessive noise	Flow too high, too high throughput; Load too high;	Check the flow rate and pressure drop;	Decrease flow rate; Avoid areas of unstable operation of the fan;
	Damaged bearings, damaged metal components;	Bearings, state of the components;	Replace bearings, damaged components;
	Unbalanced moving components;	Strange vibrations;	Calibrate / Replace fan;
Drive does not work	Power failure;	Power supply; Circuit breaker;	Restore power supply; Resetting circuit breaker;
Low efficiency of the heat exchanger	Dirt of improper recovery element	Cleaning the heat exchanger	Clean heat exchanger

Note:
Please note that air handling units are integrated into a general system. For this reason, failures may be caused by other components of the system, incorrect interaction between the unit and the system, or environmental conditions other than the specificities for the design of the unit

CE DECLARATION OF CONFORMITY

We hereby declare, under our only responsibility, that the CASALS brand products described in this manual comply with the directives 2014/35/EU (Low Voltage), 2006/42/EC (Machinery), 2014/30/EU (Electromagnetic compatibility), 2009/125/EC* (Ecodesign) and with all the standards mentioned in this instruction manual.

*The compliance of this Directive only affects to ErP marked compliant models.

VENTILACIÓN INDUSTRIAL IND S.L.

Crta. Camprodon, s/n
17860 Sant Joan de les Abadesses (Girona)
GPS: N 42° 14' 10", E 2° 17' 40"
Tel. (+34) 972720150
Fax (+34) 972721053
E-mail nacional: ventilacion@casals.tv
E-mail export: fans@casals.tv
www.casals.tv

Sr. David Samper
Dir. General



Sant Joan de les Abadesses 02/07/2018